

VERTRIEB DURCH:



**Ihr Anbieter für Geräte im Bereich
Labor, Mikrobiologie und Industrie.**

Wir sind für Sie da:

E-Mail: office@rieger-iv.at

Telefon: +43(1) 728 00 52

Fax: +43(1) 728 69 16

Rustenschacher Allee 10, 1020 Wien, Austria

www.rieger-iv.at

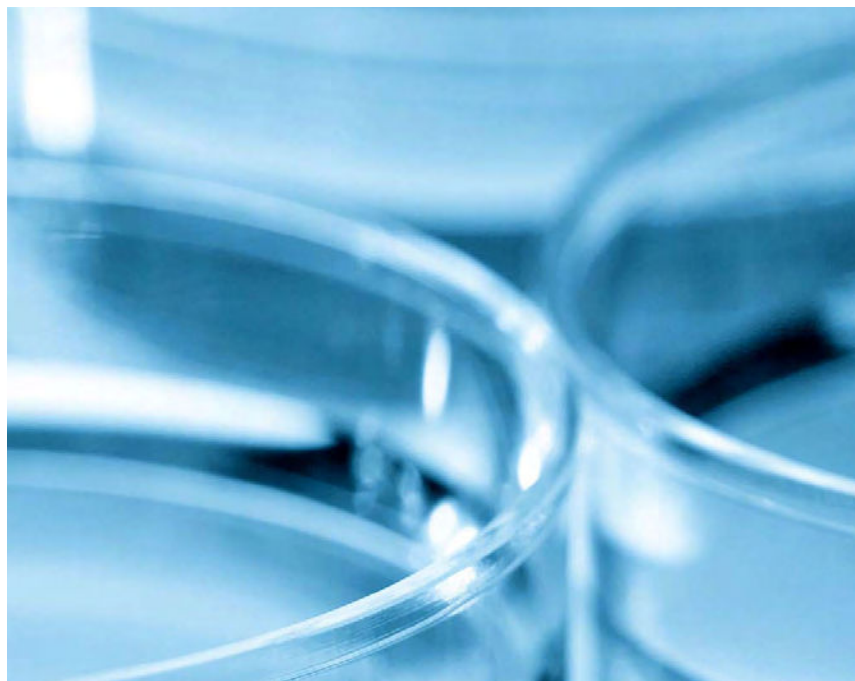

Kuhner shaker

SB50-X (OrbShake)

Orbital shaken bioreactor
for disposable bags



SB50-X and control unit

1 Disposable bag with pH & DO sensors and various ports

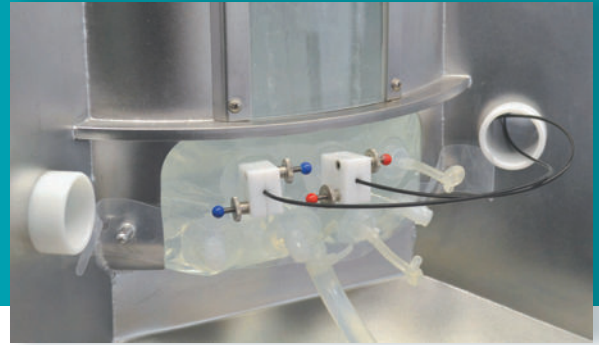

The SB50-X is an orbital shaken bioreactor for the cultivation of human, mammalian and plant cells in a disposable bag. A working volume from 15 litres up to 50 litres for the SB50-X ensures easy scale-up from microtiter plates to shaking flasks and all the way up to 200 litres. The SB50-X can be used in research, process development or production.

Performance characteristics

- + Large capacity (50L working volume) single use bioreactor system
- + Cultivation of human, mammalian and plant cells
- + Fast, simple set up
- + Easy scale-up
- + Online measurement of pH and DO

Disposable bag for a fast and simple set up

The cylindrical vessel accepts a disposable bag. This bag requires no additional mixing device, enables quick set up times and eliminates elaborate cleaning and sterilising procedures. Various ports are incorporated to allow feeding, inoculation, harvesting and sampling. The bag has built in optical sensors for pH and DO **1**.

Orbital motion

The orbital motion of the SB50-X ensures efficient liquid mixing. It allows high oxygen transfer rates with low shear forces. Mechanical stress on the cells is reduced thanks to bubble-free surface gassing with almost no frothing. This motion is particularly suitable for microcarrier cultivation. The SB50-X uses the unique Kuhner direct drive which provides accurate control of the orbital speed.

2 Reader Box-X: Online measurement of pH and DO

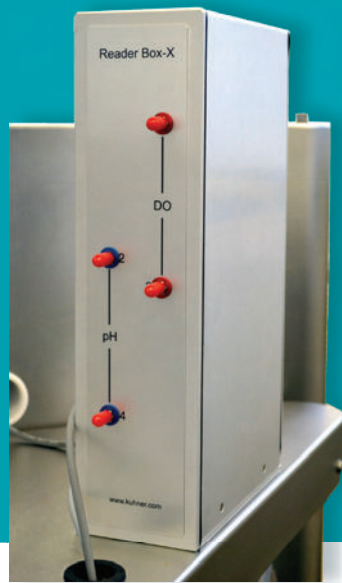

3 Filter heater

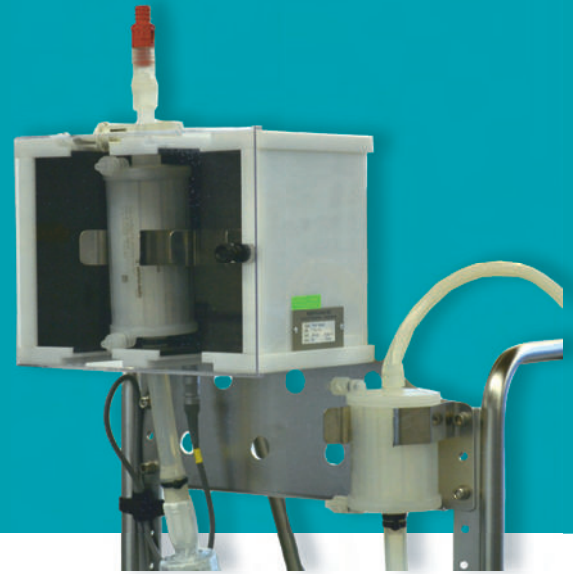

Trouble free scale-up

The SB50-X fills a gap in the scale-up chain from microtiter plates all the way up to 200 litres. The consistent hydro-dynamics of shaken bioreactors provide reproducible cultivation conditions throughout the volume range. The culture from the SB50-X can also serve as preculture or inoculum for the SB200-X.

Control unit and online measurement

The bespoke control unit, designed by Kuhner, uses the latest touch-screen technology and ISIS-X 8.0 software for data recording, calibration, programming and controlling. Technical controls for 21 CFR Part 11 compliance are built into the software.

The SB50-X can be heated or cooled. Temperature ramps are easily programmed and processed.

Online measurement of each parameter (dissolved oxygen and pH-value in the medium) is available **2**.

Pumping system

The control unit incorporates two small and one big peristaltic pump. This enables simple regulation of the pH-value, feeding and the transfer of the culture media (scale-up or processing).

Gas mixing

The SB50-X has an integrated gas mixing device (FlowCon).

Whether stabilizing the pH with CO₂, or preventing low dissolved oxygen concentrations, the gas mixer meets all user needs. Four mass flow controllers ensure highly accurate and reproducible gas mixing. An integrated pressure sensor prevents over pressure in the bioreactor by reducing the gas flow in the first step (1. limit) and shutting off the gas flow in the second step (2. limit). Step limits can be freely programmed by the user. Integrated air filters and back pressure valves ensure interference free and long operating times for the FlowCon.

Filter heater **3**

A height adjustable filter heater, with up to two exhaust filters, is installed above the cylindrical vessel. Special emphasis has been placed on developing a user friendly unit. The filter heater combats any water vapour condensation in the outlet air which might cause the membranes to block. The temperature is monitored and controlled by ISIS-X 8.0 software.

The SB50-X was developed and tested in collaboration with ExcellGene SA (Monthey, Switzerland) and the Swiss Federal Institutes of Technology EPFL (Lausanne, Switzerland).

Dimensions SB50-X

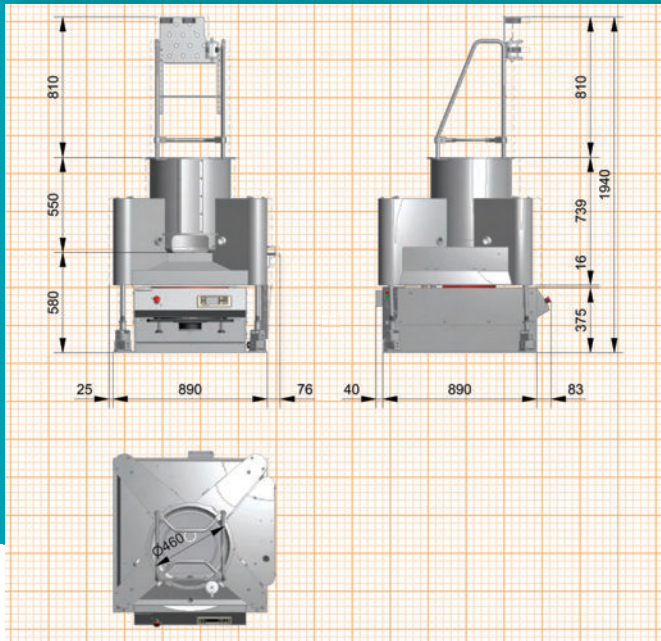

Dimensions Control unit

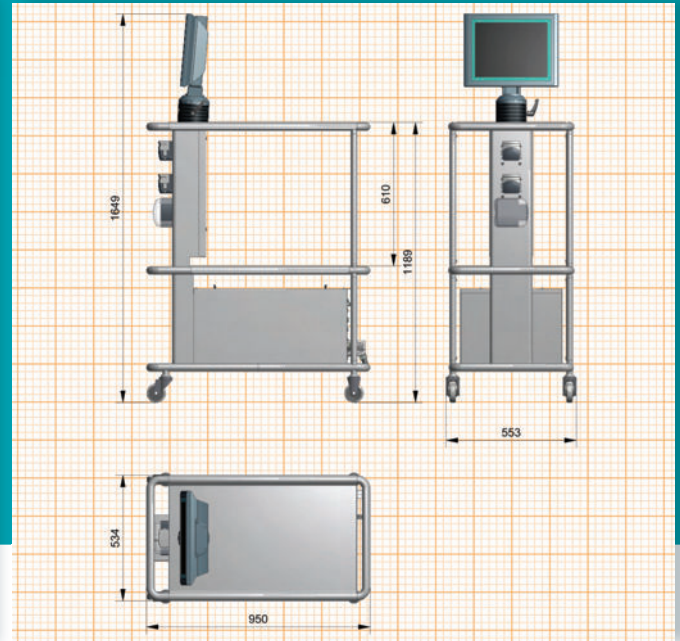

Technical data

Shaken bioreactor

• Order number	SMX7500
Shaker speed	max. 150 rpm
Shaker diameter	50 mm (orbital motion)
Weight	approx. 340 kg without liquid
Accuracy, absolute	0.1 rpm
Setting, digital	1 rpm
Active brake	adjustable
Interface	CAN-Bus, RS232
Temperature	up to 50°C
Cooling	cooling coils are incorporated for connection to an external cooling system (pressure <0.2bar)

• Mains connection

SMX1021	220 - 240 V / 50-60 Hz
SMX1023	110 - 120 V / 50-60 Hz
SMX1024	95 - 105 V / 50-60 Hz

• Filter heater	SMX7120
Capacity	2 exhaust filters
Temperature range	Ambient temperature up to 70°C, monitored and controlled by ISIS-Software

• Reader Box	SMX7130
Oxygen Sensor	Optical measuring method
Range	0-100%
Accuracy	± 0.01%O ₂ at 0.21%O ₂ ± 0.1%O ₂ at 20.9%O ₂
Drift	< 0.015%O ₂ per day
Temperature range	up to 50°C
pH Sensor	Optical measuring method
Range	5.5 - 8.5
Accuracy	± 0.05 pH at pH 7 with one point calibration ± 0.10 pH at pH 7 with pre calibration
Drift	< 0.005 pH per day
Temperature range	up to 50°C

4 ISIS-Software

5 Pumps

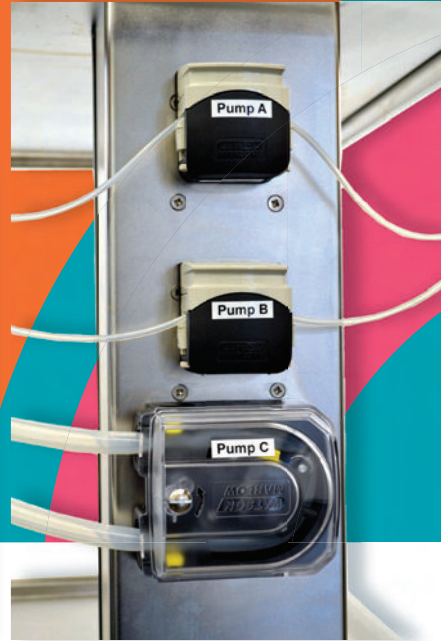
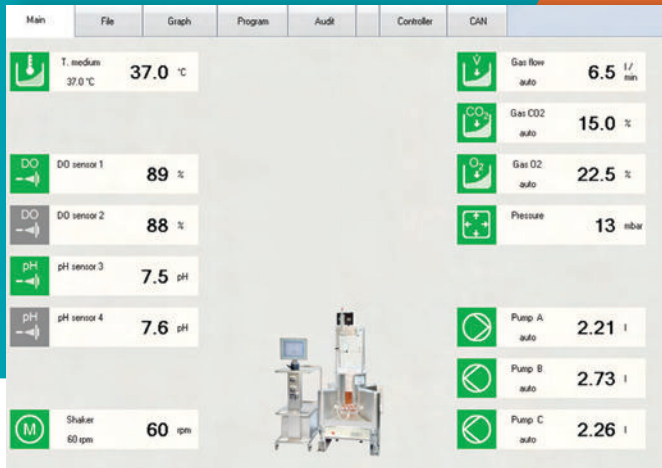

Control unit

with touchscreen monitor, ISIS-Software, pumps & gas mixing device

Order number	SMX7110
Weight	120kg
Monitor	15" touchscreen monitor
ISIS-Software 4	for monitoring, calibration, controlling
Monitoring	O ₂ , pH, shaking speed, temperature
Calibration	pre-calibrated sensors in bag
Recalibration	one point recalibration is possible
Applicable	XP/Vista/Win7&8
GMP	21 CFR Part 11 compliance (audit trail)

1.6 mm wall tubing		2.4 mm wall tubing	
Bore diameter (mm)	Flow rates (ml/min at 100rpm)	Bore diameter (mm)	Flow rates (ml/min at 100rpm)
0.5	3.4	0.5	4.1
0.8	7	0.8	10.5
1.6	27	1.6	42
3.2	100	3.2	170
4.8	220	4.8	380
6.4	360	6.4	680
8.0	500	8.0	1040
		9.6	1500

3 Gas mixing:

Mixing up to four gases

Gas mixtures can also be connected



• Gas mixing 6

Number of mass flow controllers	4
Ambient conditions	5-40 [°C], max. 85 [%rH]
Input	up to 4 gases, push in connector [6 mm] (air, oxygen, nitrogen, carbon dioxide) (gas mixtures can also be connected)
Input pressure	1-2 bar
Output	1, (tube fitting for tube ID 13 [mm])
Flow rate	0 - 20 [sL/min]
Accuracy	±1.5% from the end value
Pressure sensor	integrated, 0-400 [mbar], programmable prevents over pressure in the connected vessel
Air filter	integrated, prevents blocking the mass flow controllers
Back pressure valve	integrated, prevents reflux into the mass flow controllers
Controlled filter heating box	for the outlet filters, prevents blocking of the filters caused by condensation (only air inlet and outlet with silicon tubing)
C-Flex material	for the tubing, enables the user to connect additional components via tube welding



Options

Cooling

The SB50-X has a cooling ring embedded in the base plate. Cooling is achieved by connecting an external cooling device. An integrated valve, controlled by the ISIS-Software, regulates the set point temperature.

IQ-OQ Documentation

IQ-OQ (Installation Qualification and Operation Qualification) is an equipment qualification required for GMP procedures. Documentation is available from Kuhner and Qualification services can also be provided at the customer's premises.

Tubing support bar 7

Order number: SMX714001

A tubing support bar is available for attaching the various tubes (feeding, medium, air and pH regulation) and keeping them tidy.

Accessories

Disposable bag

Order number: SMX750001

The gamma irradiated bag for the Kuhner shaken bioreactor requires no additional mixing device, enables quick set up times and eliminates elaborate cleaning and sterilising procedures. The single-use bag has a working volume from 15 litres up to 50 litres. Various ports are incorporated to allow feeding, inoculation, harvesting and sampling. The bag has built in optical sensors for pH and DO.

Interfaces

Kuhner shakers are equipped with a CAN-bus. CAN-USB, CAN-Ethernet, EMI-60 and NET-60 are all well established interfaces.



Shakers & Accessories

www.kuhner.com

Kuhner

Represented by:

Adolf Kühner AG • since 1949

Dinkelbergstrasse 1
CH-4127 Birsfelden (Basel)
Switzerland

phone +41 (0) 61 319 93 93
fax +41 (0) 61 319 93 94
office@kuhner.com

www.kuhner.com