

ThawSTAR® Automated Cell Thawing System

The Industry Leader in Thawing Technology

Experts in safe, automated thawing and advanced transport solutions for your cryopreserved biologic materials.

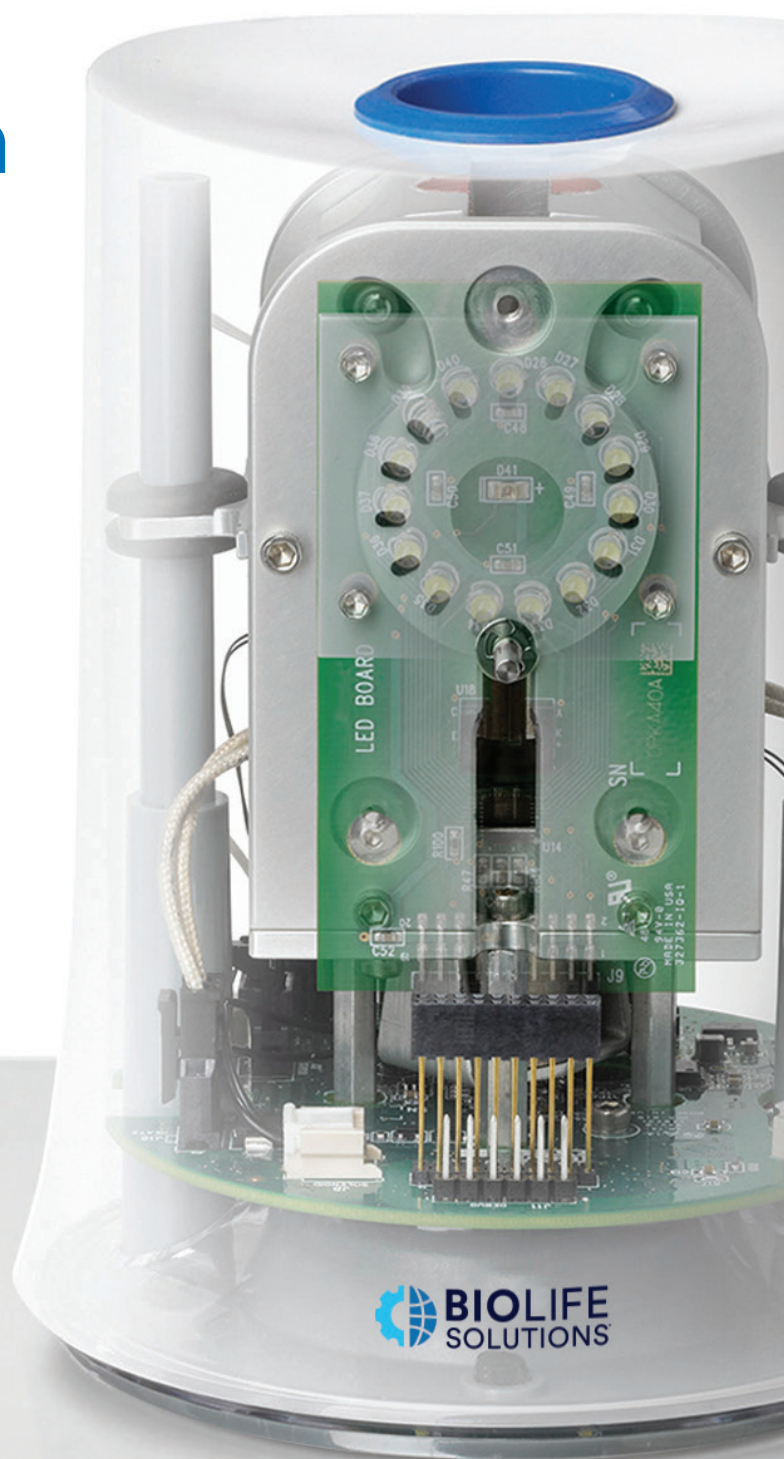

Automated, Water-Free Thawing System for Cryobags

ThawSTAR® CB is an automated, water-free thawing system designed for 25-1000 mL cryobags. Operated through a user-friendly software interface, the ThawSTAR CB System standardizes and streamlines biologic material thawing for consistent and documented results.

- **Consistent Thawing** - Automated algorithm driven thawing with biomaterial temperature sensing technology.
- **Easy Operation** - Intuitive software interface allows access control, enforcement of QC procedures, and optimized thawing algorithms. Compatible with common cryobag form factors from major manufacturers.
- **Biomaterial Safety** - Single use Barrier Bag reduces the risk of biomaterial loss, and/or contamination; and positions cryobag for optimal thaw performance.
- **Precise and Reliable** - Patent-pending heating technology and real-time temperature-sensing analytics manage heat application for a reliable and documented thaw. An uneditable thaw archive is stored in internal memory.



HOW IT WORKS

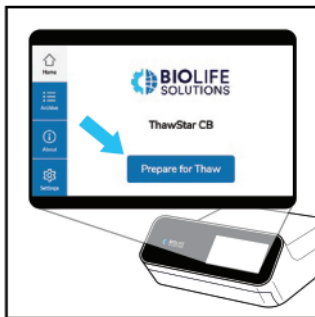

Select "Prepare for Thaw"



Enter Valid User Name



Select Thaw Profile

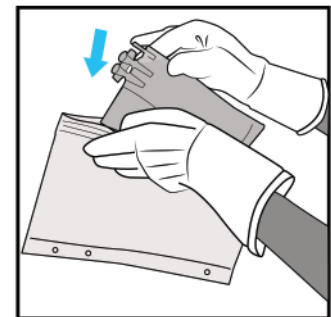

Insert Frozen Cryobag into Barrier Bag



Place Bag in Drawer

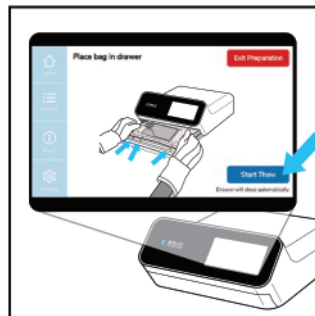

Select "Start Thaw"



Wait for Thaw to Complete (2-8 minutes)



Remove Thawed CryoBag

PRODUCT SPECIFICATIONS

Installation	Self-installed, out-of-the-box operation
Dimensions (H x W x D)	19.5 x 38.5 x 45 cm (8 x 15 x 18 in)
Weight	11.3 kg (25 lb)
Cryobag size	25 - 1000 mL
Bag type	Compatible with cryobags from OriGen®, Charter® and Miltenyi®
Thawing temperature	Driven by protocol settings, ranging from 37°C - 50°C
Thawing time	2-8 minutes (depending on fill volume)
Input voltage	100-120V, 200-240V
Power requirements	Maximum 8A
Accessories	ThawSTAR CB Barrier Bag (25, 50, 250, 500, 750, and 1000 mL)

ThawSTAR® CB is for research or further manufacturing use.

ORDERING INFORMATION

Part Number	Product Description
AST-90000	ThawSTAR CB Automated Thawing System with 6 standard bag options
AST-90001	ThawSTAR CB Automated Thawing System with 6 standard bag options plus One Optimized Thawing Algorithm
AST-90025	ThawSTAR CB Barrier Bags, 25 mL, 25 per pack
AST-90050	ThawSTAR CB Barrier Bags, 50 mL, 25 per pack
AST-90250	ThawSTAR CB Barrier Bags, 250 mL, 25 per pack
AST-90500	ThawSTAR CB Barrier Bags, 500 mL, 25 per pack
AST-90750	ThawSTAR CB Barrier Bags, 750 mL, 25 per pack
AST-91000	ThawSTAR CB Barrier Bags, 1000 mL, 25 per pack
AST-90011	ThawSTAR CB Extended Limited Warranty (one year)
AST-CUST	ThawSTAR Algorithm Optimization (one protocol)
AST-90013	ThawSTAR CB Power Cords



Automated Vial Thawing Systems

BioLife Solutions now offers three automated thawing systems for AT-Closed Vials®:

- ThawSTAR AT2 for 2.0 mL AT-Closed Vials
- ThawSTAR AT6 for 6.0 mL AT-Closed Vials
- ThawSTAR AT10 for 10 mL AT-Closed Vials.

ThawSTAR AT-Closed Vial® Thawing Systems replace manual methods such as water bath and hand thawing and can be leveraged early in the R&D phase and scaled into high-volume commercial manufacturing. Contact BioLife Solutions regarding your vial size, vial load, initial vial temperature and desired final thaw state to learn how quickly and easily a dedicated thaw profile can be created for your specific application. BioLife Solutions will adjust the advanced thawing algorithm to provide a consistent and scalable thawing outcome for your cells that will service your specific cell therapy product through discovery, clinical trials, and manufacturing.



ThawSTAR® AT-Closed Vial® Systems Provide Reproducible Thawing Results

Eliminate human-dependent variability

ThawSTAR AT-Closed Vial System:

- Eliminates the contamination risk of water bath thawing procedures
- Simplifies user training
- Delivers consistent thawing performance

ThawSTAR® AT Transporter: How it Works

The transporter is comprised of an insulative foam base and lid, and an AT Core that accommodates 2.0 mL, 6.0 mL and 10.0 mL AT-Closed Vials®.

ThawSTAR® AT Transporter is a portable solution for handling and transporting frozen cell therapy vials from long-term storage in vapor phase liquid nitrogen or in a -80°C freezer to downstream thawing with the ThawSTAR Automated Cell Thawing Instrument.

Specifications



ThawSTAR® AT2 Instrument

Dimensions (Diameter x Height)	11.0 x 14.5 cm (5.7 x 4.3 in)
Capacity	One 2.0 mL AT-Closed Vial®
Fill volume	0.5 - 2.0 mL
Thawing time	Approximately 3 - 5 minutes
Compliance	CE mark (EMC and Safety), EN 60601-1-2, EN 61010-1, RoHS, WEEE



ThawSTAR® AT6 Instrument

Dimensions (Diameter x Height)	11.0 x 14.5 cm (5.7 x 4.3 in)
Capacity	One 6.0 mL AT-Closed Vial®
Fill volume	2.0 - 5.0 mL
Thawing time	Approximately 3 - 6 minutes
Compliance	CE mark (EMC and Safety), EN 60601-1-2, EN 61010-1, RoHS, WEEE



ThawSTAR® AT10 Instrument

Dimensions (Diameter x Height)	11.0 x 14.5 cm (5.7 x 4.3 in)
Capacity	One 10.0 mL AT-Closed Vial®
Fill volume	4.0 - 8.0 mL
Thawing time	Approximately 3 - 6 minutes
Compliance	CE mark (EMC and Safety), EN 60601-1-2, EN 61010-1, RoHS, WEEE



ThawSTAR® AT Transporter

Dimensions (L x W x H)	20.0 x 16.0 x 16.0 cm (7.8 x 6.3 x 6.3 in)
Capacity	Six 2.0 mL, 6.0 mL or 10.0 mL AT-Closed Vials®
Dry ice used	~250 g
Holding temperature	< -70°C
Holding time	> 1 hour

Ordering Information

ThawSTAR® Automated Cell Thawing System

AST-650	ThawSTAR® AT2 Automated Cell Thawing Instrument
AST-700	ThawSTAR® AT6 Automated Cell Thawing Instrument
AST-710	ThawSTAR® AT10 Automated Cell Thawing Instrument
AST-701	ThawSTAR® AT Transporter for six 2.0 mL 6.0 mL or 10.0 mL AT-Closed Vials®

Automated Generic Vial Thawing Systems

ThawSTAR® Generic Vial Thawing System utilizes patent-pending STAR™ sensing technology to customize the thaw for each vial - whether obtained from liquid nitrogen or -80°C storage.

ThawSTAR® Automated Cell Thawing Instrument features intuitive operation, making integration and standardization easy. Simply insert a frozen cryogenic vial and retrieve it when the vial is gently raised at the end of the thaw cycle, (approximately 2.5 minutes). The small footprint and audio/visual feedback enable use in a cell culture hood with the rest of the workflow. The ThawSTAR Instrument reduces variability in cell preparations by critical control of vial thawing. This serves to remove operator error and day-to-day variations within a site as well as site-to-site variation.



ThawSTAR® CFT Transporter: How it Works

Comprised of an outer insulative foam lid and base, and an internal round CFT2 Core that accommodates up to five 1.8 or 2.0 mL (CFT2), or five 1.5 mL (CFT1.5) cryogenic vials.

Prior to using the ThawSTAR® CFT Transporter, a thin layer of dry ice is added to the bottom of the base. The round CFT2 Core is placed over the dry ice and allowed to equilibrate to dry-ice temperature (approximately 20 minutes). The frozen vial is then extracted from storage and quickly placed into the module. The lid is placed securely on top of the base and all samples are maintained at dry ice temperature until transported to the thawing location.



Performance Data

Ex-Vivo B Cells: Post-thaw viability and consistency compared to water bath

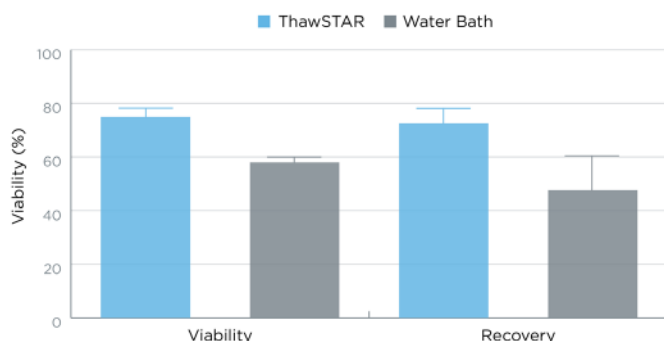

A total of 6 vials (2 each from 3 donors) containing ex vivo stimulated B cells, were frozen in a -80°C freezer using a CoolCell® cell freezing container and then stored in liquid nitrogen (LN2) for two weeks. One vial from each donor was removed from LN2, placed into a ThawSTAR® CFT2 Transporter and thawed in a ThawSTAR CFT2 Automated Cell Thawing Instrument. The other vial from each donor was removed from LN2 and hand-carried to a water bath. The vials transported and thawed in the ThawSTAR Transport and Thawing System performed better in terms of cell viability and recovery.

- Data generated by UCSF Diabetes Center and Transplant Surgery

Specifications



ThawSTAR® CFT2 Instrument	
Dimensions (Diameter x Height)	11.0 x 14.5 cm (5.7 in x 4.3 in)
Capacity	1.8 - 2.0 mL cryogenic vial
Fill volume	0.8 - 1.5 mL
Vial Brand	Compatible with major vial manufacturers
Thawing time	Typically less than 3 minutes
ThawSTAR® CFT2 Transporter	
Dimensions (Diameter x Height)	11.4 x 15.0 cm (4.5 x 6.0 in)
Dry ice used	~1 50 g
Holding temperature	< -70°C
Holding time	> 1 hour



ThawSTAR® CFT1.5 Instrument	
Dimensions (Diameter x Height)	11.0 x 14.5 cm (5.7 in x 4.3 in)
Capacity	1.5 mL cryogenic vial
Fill volume	0.5 - 1.5 mL
Vial Brand	Nalgene® 5000-1020
Thawing time	Typically less than 3 minutes
ThawSTAR® CFT1.5 Transporter	
Dimensions (Diameter x Height)	11.4 x 15.0 cm (4.5 x 6.0 in)
Dry ice used	~1 50 g
Holding temperature	< -70°C
Holding time	> 1 hour

IOPQ Packet for ThawSTAR® CFT2 System

Qualification documentation and testing accessories based on GxP industry standards and the GAMP® 5 methodology.



Contents include:

- Comprehensive documentation makes thawing easy to authenticate
- Testing accessories included with Qualification Packet
- Step-by-Step IOPQ protocol and report templates for thawing in a controlled environment

Ordering Information

ThawSTAR® Automated Cell Thawing System

AST-600	ThawSTAR® CFT2 Cell Transport and Thawing System, complete
AST-601	ThawSTAR® CFT2 Automated Cell Thawing Instrument
AST-602	ThawSTAR® CFT2 Transporter for up to five 1.8 or 2.0 mL cryogenic vials
AST-614	ThawSTAR® CFT2 IOPQ Packet for ThawSTAR CFT2 System
AST-603	ThawSTAR® CFT2 Confirmation Vials
AST-630	ThawSTAR® CFT1.5 Cell Transport and Thawing System, complete
AST-631	ThawSTAR® CFT1.5 Automated Cell Thawing Instrument
AST-632	ThawSTAR® CFT1.5 Transporter for up to five 1.5 mL cryogenic vials
AST-606	ThawSTAR® Instrument Power Supply and Adapter
AST-611	ThawSTAR Extended Limited Warranty (North America, includes Preventative Maintenance)
AST-613	ThawSTAR Extended Limited Warranty (International, includes Preventative Maintenance)

The ThawSTAR® System is for research or further manufacturing use.

Low-Capacity Temperature Stability System

Breakthrough portable solution for handling and transporting valuable frozen biological materials and temperature-sensitive samples, or freezing samples at a collection site.

The closed-cell high-density polyethylene foam construction of the lid and base chamber is durable, non-absorbent, and remains comfortable to the touch even when loaded with dry ice and frozen materials. Magnetized lid ensures safe transport of contents. The dry ice retainer or DIR™ and thermo-conductive shelf plate are constructed of aluminum alloy anodized for durability.



Delivers Reliable Performance

BioT™ ULT Transporter maintains samples at -50°C for 24 hours and the BioT LN2 Transporter maintains cryogenic temperature at -150°C for approximately 2 hours.

- Ready to use in approximately 10 minutes
- Lightweight, easy to carry
- Intuitive assembly, durable
- Easy to clean and store

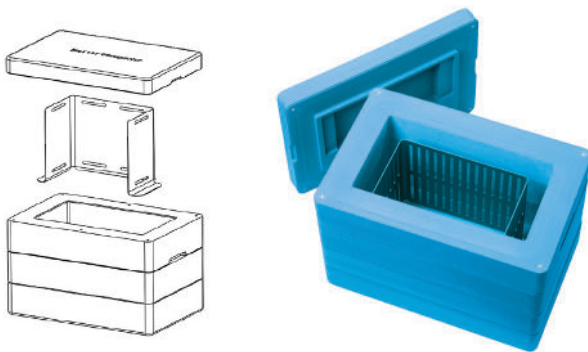

BioT™ ULT Transporter is comprised of three parts: magnetized lid, DIR™ dry ice retainer and base chamber. To begin, insert the DIR retainer, flanges down, into the base chamber. Add pelletized dry ice into the cavity between the DIR retainer and the base chamber walls, filling to the top of the DIR retainer. A full load of dry ice is approximately 13 lbs (5.8 kgs). The internal chamber will reach optimal working conditions ($<-70^{\circ}\text{C}$ to -50°C) within approximately 10 minutes and will be ready for use.

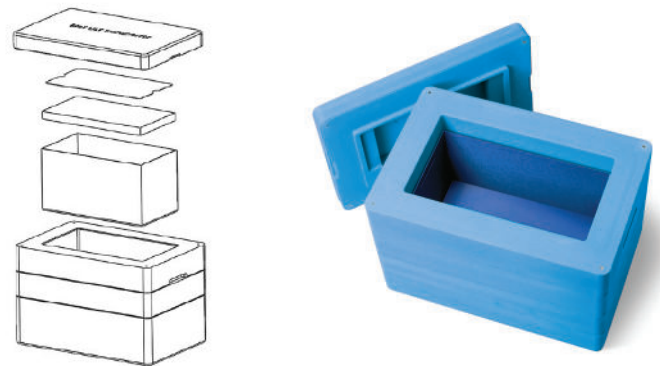

BioT™ LN2 Transporter is comprised of five parts: magnetized lid, thermo-conductive basket, thermo-conductive shelf plate, absorbent/baffle pad and base chamber. To begin simply insert the thermo-conductive basket into empty base chamber, followed by the absorbent/baffle pad. Place the thermo-conductive shelf plate into the basket on top of the absorbent/baffle pad. With the addition of LN2, (~ 2.7L) the internal chamber will reach $<-150^{\circ}\text{C}$ within approximately 10 minutes.

Styrofoam Box and Dry Ice: 0.6 Inches Below -50°C

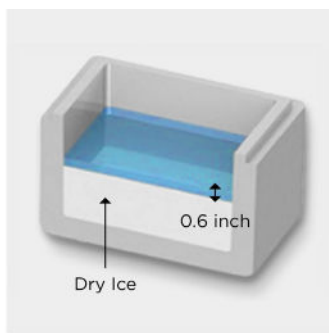
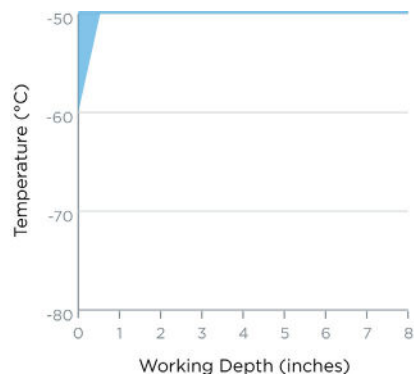

A dry ice-filled Styrofoam box is currently the standard method used for receiving, handling and transporting valuable frozen samples. However, only a 0.6 inch (1.5 cm) high zone above the dry ice stays below -50°C for 2 hours. Worse, at 2 inches (5.0 cm) above the dry ice - the top of a standard 2-inch cryostorage box- the temperature is above -20°C.

BioT™ ULT Transporter: 8.0 Inches Below -50°C

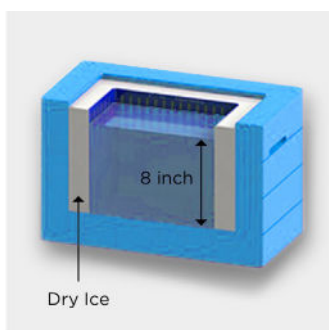
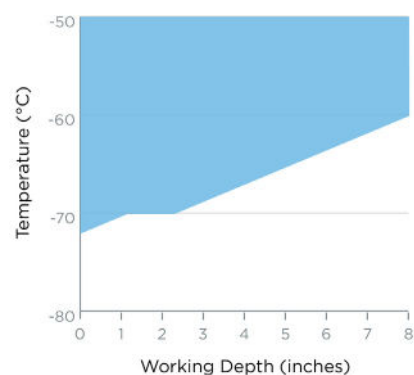

BioT™ ULT Transporter provides a stable ultra-low temperature (< -70°C to -50°C) work zone 8.0 inches (20.3 cm) deep. Up to 8 standard 2-inch cryostorage boxes will remain safely below -50°C for over 8 hours with the lid open and over 24 hours with the lid closed with one charge of dry ice.

Specifications

BioT™ ULT Transporter	
-70°C to -50°C	Lid off: over 8 hours Lid on: over 24 hours
Dimensions (L x W x H)	Internal working area: 29.0 x 16.2 x 20.3 cm (11.4 x 6.4 x 8.0 in) External: 50.8 x 33.8 x 33 cm (20.0 x 13.3 x 13 in)
Amount of dry ice required	5.4 kg (12.8 lb)
Weight empty	3.6 kg (8.0 lb)
Weight with dry ice	9.0 kg (20.8 lb)
Working depth <-50°C	up to 20 cm (8.0 in) from chamber floor
Capacity	8 standard 2-inch cryostorage boxes 18, 250 mL cassettes

BioT™ LN2 Transporter	
-180°C to -150°C at < 6"	Lid off: 1 - 1.5 hours Lid on: 2 - 2.5 hours
Dimensions (L x W x H)	Internal working area: 36.3 x 19.8 x 17.8 cm (14.3 x 7.8 x 7.0 in) External: 50.8 x 33.8 x 33 cm (20.0 x 13.3 x 13 in)
Amount of LN2 required	~2.7 L to charge unit
Weight empty	4.0 kg (8.8 lbs)
Weight with LN2	6.2 kg (13.6 lbs)
Working depth < -150°C	up to 15.2 cm (6 inches) from floor plate
Capacity	> 6 standard 2-inch cryostorage boxes 24, 250 mL cassettes

Ordering Information

BioT™ ULT Transporter	
AST-500D	BioT™ ULT Transporter, magnetized lid, DIR™ dry ice retainer and base chamber
AST-500L	BioT™ LN2 Transporter, magnetized lid, thermo-conductive basket, thermo-conductive shelf plate and absorbent pad and base chamber
AST-501D	BioT™ DIR™ Retainer, thermo-conductive dry ice retainer
AST-501L	BioT™ LN2 Basket, thermo-conductive basket, thermo-conductive shelf plate and absorbent pad

Ultra-Low, High-Capacity Mobile Temperature Stability System

BioT™ ULT Workstation is a breakthrough solution for handling and transporting valuable temperature-sensitive biomaterials, or freezing samples at collection site.

The dry ice-based BioT™ ULT Workstation provides a secure ultra-low temperature (ULT) -75° to -50°C work area for processing or transporting critical frozen samples. The patent-pending DIR™ cooling insert technology ensures that samples are completely immersed in temperatures below -50°C during the operating period. Requiring minimal dry ice, the chamber equilibrates to -50°C within 30 minutes and continues to cool for over 15 hours with the lid open with a single charge of dry ice.

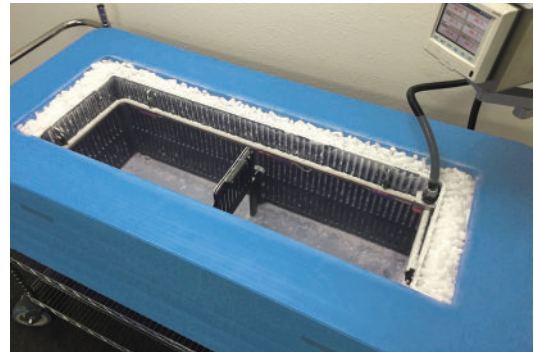

Maintains < -75° to -50°C for 15 hours

ULT handling and transport for a variety of applications

- Cherry-picking, sorting or other short term handling of critical samples outside a -80°C freezer
- Controlled-temperature transfer of frozen samples within and between facilities
- Transfer of temperature-sensitive materials to long-term storage tanks
- Preparing, labeling or packaging of frozen samples for shipment



Performance Data

BioT™ ULT Workstation: 10.0 inches below -50°C

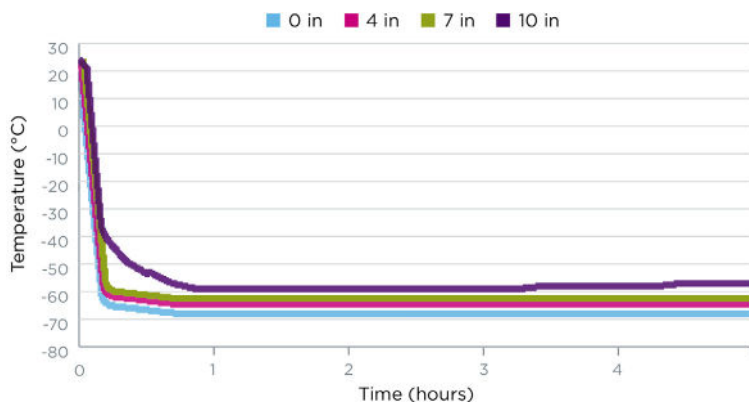

BioT™ ULT Workstation equilibrates to <-50°C in less than 30 minutes and entire chamber maintains temperature stability for over 15 hours. Temperature measured at 0 inches (blue), 4 inches (red), 7 inches (green), 10 inches (lavender).

Specifications

BioT™ ULT Workstation

Internal Dimensions (L x W x H)	105.4 x 33.0 x 35.5 cm / 41.5 x 13.0 x 14.0 in
External Dimensions (L x W x H)	152.4 x 71.1 x 44.5 cm / 60.0 x 28.0 x 17.5 in
Hours of <-50°C cooling	Lid open: over 15 hours
Amount of dry ice required	41 kg (90 lb)
Working depth <-50°C	up to 25.4 cm (10 in)

Ordering Information

BioT™ ULT Workstation

AST-508	BioT™ ULT Workstation, dry ice based freezing Includes: container base, lid and cart. Temperature monitoring and alarm system available upon request.
---------	---



info@biolifesolutions.com | biolifesolutions.com

©2020. BioLife Solutions. All rights reserved. Patents pending. BioLife Solutions, ThawSTAR, BioT, STAR designations are trademarks owned by BioLife Solutions.

BR-AST-19017RO3